

OMC PZT assembly_gluing sheet

PZT: #26

Mirror: C6 $R_c=2.573m$

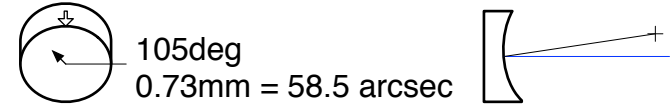
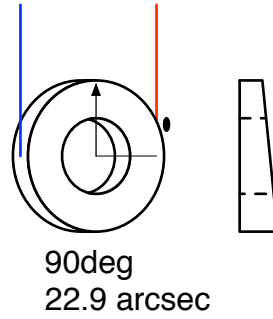

Mounting Prism: #16

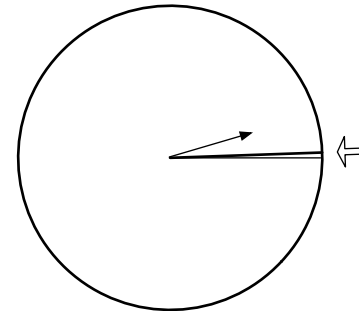
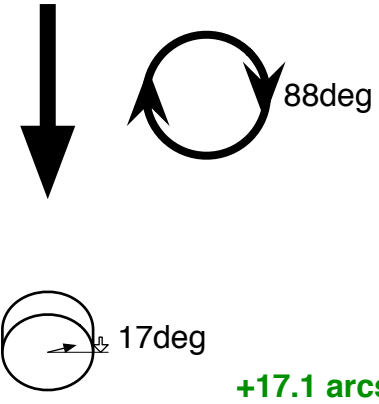
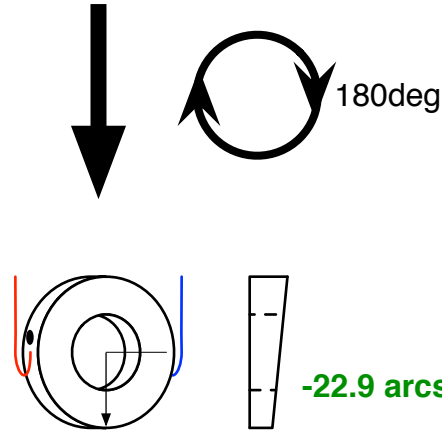
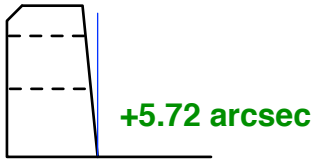

OMC PZT assembly_gluing sheet

PZT: #23

Mirror: C5 $R_c=2.573m$

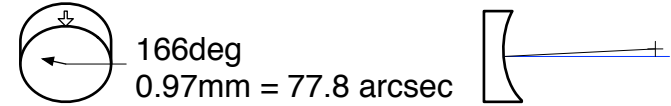
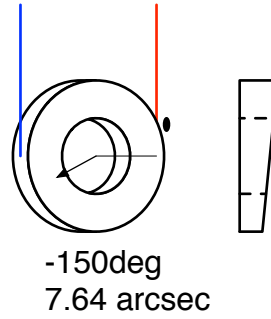

Mounting Prism: #20

